

2017

TOP SHOOTER'S CHOICE

TOTAL PERFORMANCE ARE MADE OF PRECISION

2017 PRODUCT GUIDE



2017 PRODUCT GUIDE  **FIVICS**
ARCHERY

Address » 42, Gwonseon-ro 668beon-gil, Gwonseon-gu, Suwon-si, Gyeonggi-do, Korea
Tel » +82-31-245-6388 Fax » +82-31-245-6386 E-mail » info@fivics.com



Follow us on Twitter!
<https://twitter.com/FIVICSARCHERY>



Like us on Facebook!
<https://www.facebook.com/fivics.korea>



Subscribe to us on YouTube!
<https://www.youtube.com/user/fivicskorea>

Note: At the time of production of our 2017 Product Guide, the bows, limbs, color options, and all other accessories shown, and the information contained, had been thoroughly checked for accuracy. However, in the event an error was made, Fivics reserves the right to notify our dealers and customers at its discretion. Additionally, Fivics reserves the rights to modify, change or discontinue products shown in this publication without notice. Before using bows and other archery equipment, read all safety guidelines and warnings in the owner's manual or Online at www.fivics.com.



For more information visit us online at
www.fivics.com

FIVICS BOW LIMITED LIFETIME WARRANTY

Fivics recurve handles are guaranteed against manufacturing defects in materials and workmanship to the original owner for the life of the product.

FIVICS

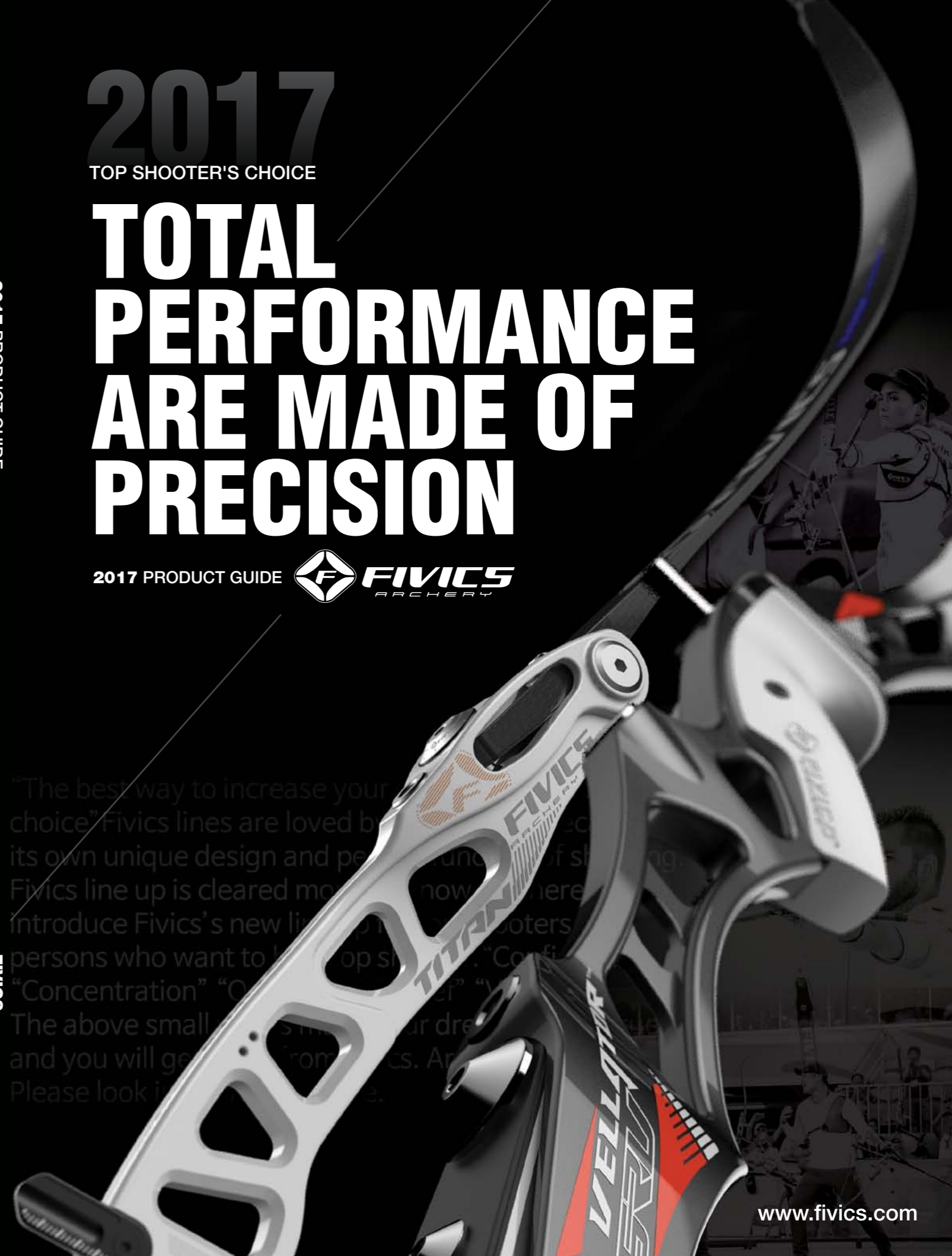

www.fivics.com



FIVICS LIMBS FACTORY

Fivics's own facility of limbs factory and starting from 2016. Fivics used to make their own limbs with some of partners, like OEM, but due to lack of experience and it didn't make Fivics satisfied with requirement, Fivics took new challenges, own facility of limbs factory. From now on, Fivics can supply more better quality, more better ideas on the limbs and most reasonable price to all of our customers.

Unlimited improvement

Fivics is only the one who can do endless challenge, make full passion like fire and make you "If Fivics, they can make new revolutionary idea"



No one has done it yet, but it's worth doing. Fivics developed new material and has advanced equipment by new and refresh idea toward archery.



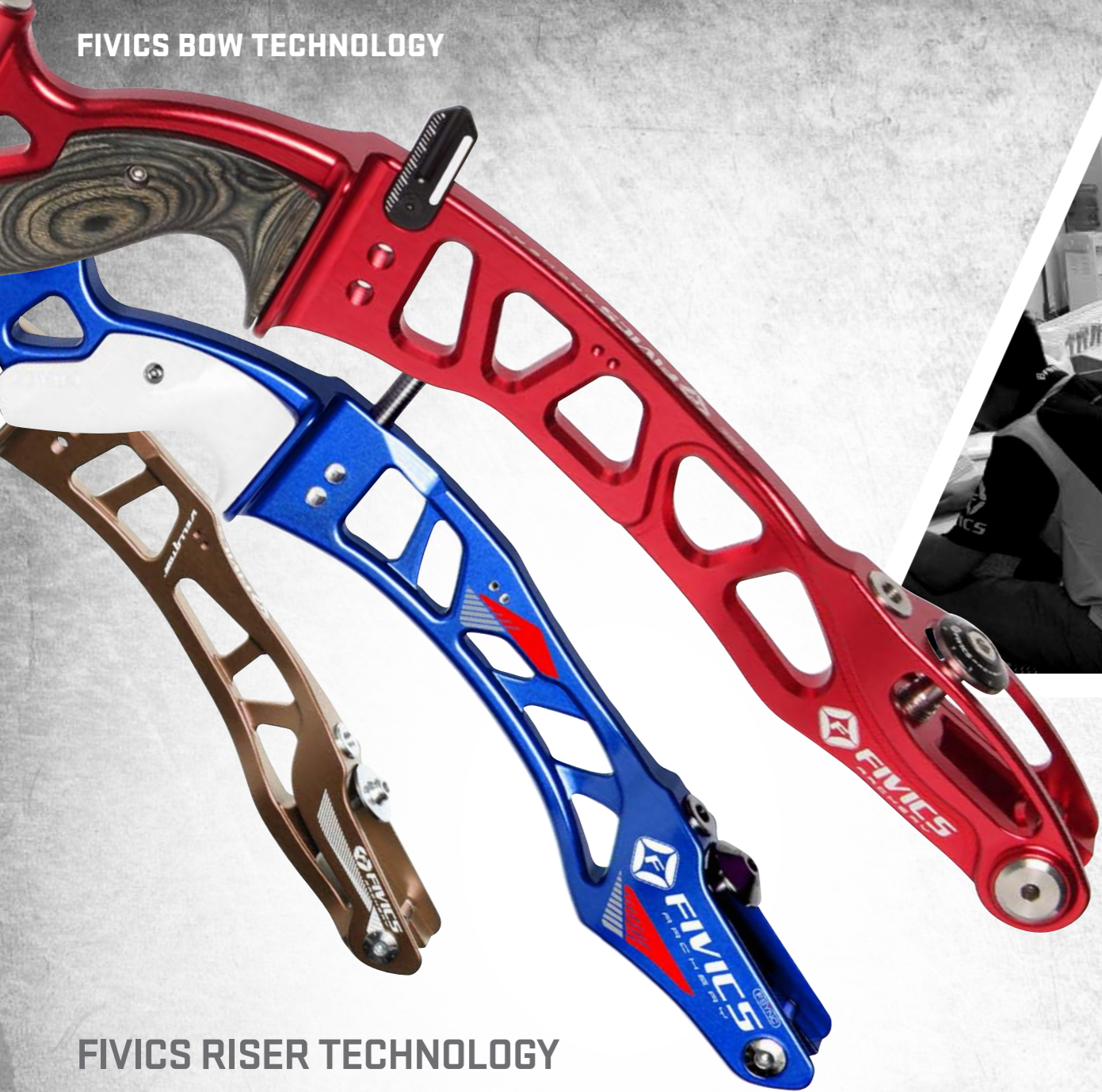

FIVICS RISER TECHNOLOGY

Abandon existing ways of thinking and promote new ideas with sharp senses. Even I win today, there is no way to win again tomorrow. Endless development can make Fivics alive and it is saying "Vitality"



DESIGN YOUR SHOOTING !

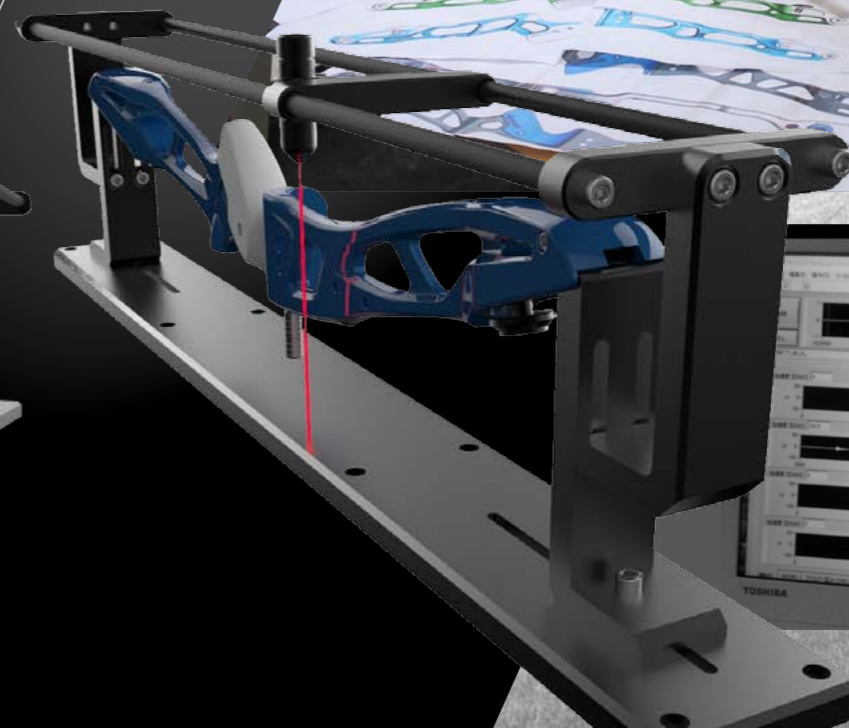
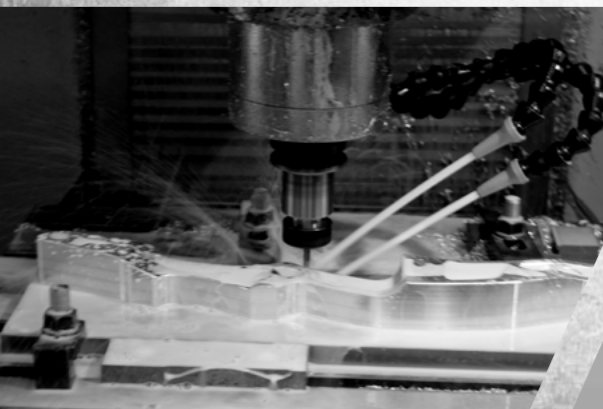



FIVICS[®]
ARCHERY
Team



Thanks to our shooters in Rio

81shooters choose Fivics Saker Finger tab from total 128shooters(63%)
It was our pleasure and we feel confidence what they chose Fivics high quality equipment from all around world.
We would like to say thanks to all of shooters.
We will do our best to support you and make you good score from much better equipments.
Thank you very much
TEAM FIVICS

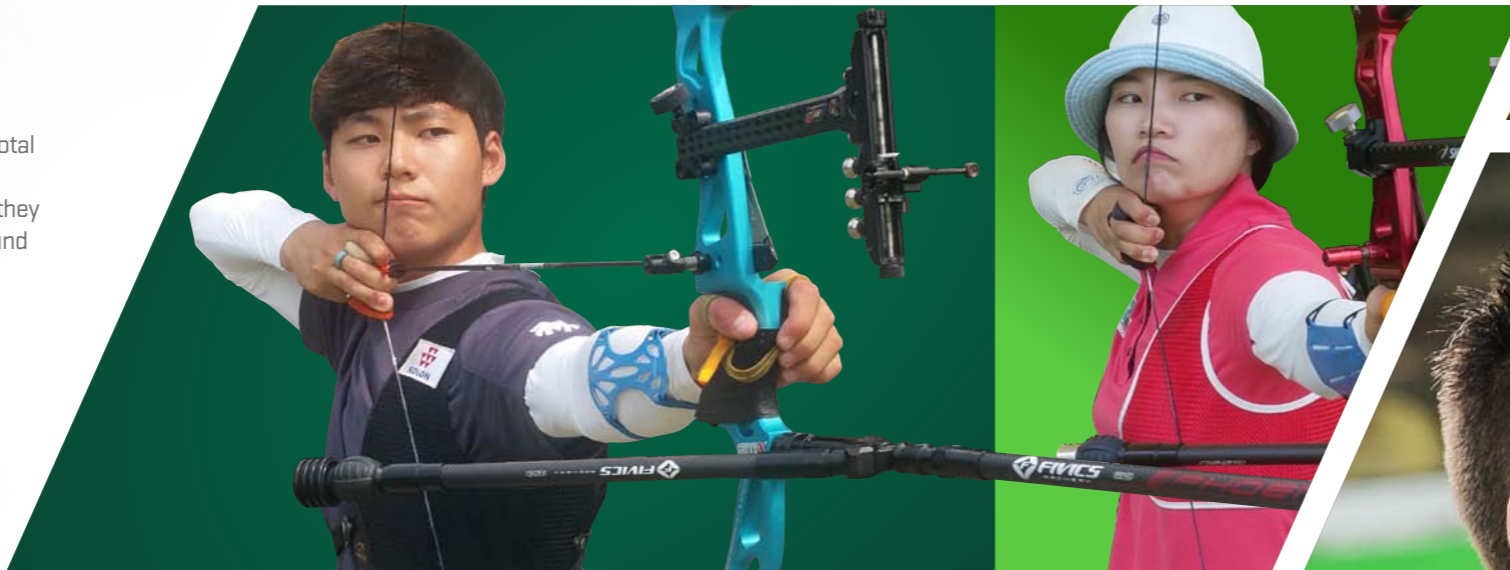

128 shooters in Rio 2016,
81 top shooter's choice

TITAN X2™

HT0525 » TITAN X2 RISER

- Superfine CNC milling
- Special unique designed wooden grip
- Slow production
- Perfect centroidal balance
- Flawless coating
- Deep color from Anodizing
- Showy color from painting

PROCESSING » **CNC**
 WEIGHT » **1,315g(25") / 1,330(27")**
 MATERIAL » **AL 6061**
 TYPE » **RH/LH**
 GRIP » **Cherry Wood**
 COLOR » **Anodized & Painted**



TITAN

LTW05 » TITAN X2 WOOD CORE LIMBS

- Clear and powerful shooting
- New Material : **MONOCOQUE** UD carbon
- Light weight
- New designed tip part

MATERIAL » **Double angled Full Carbon**
 CORE » **Wood core**
 BOW LENGTH » **66",68",70"**
 DRAW WEIGHT(lbs.) » **32#-50#**

** Fivics's all limbs are installed to all Fivics's riser and others.*



TITAN

LTF05 » TITAN X2 FOAM CORE LIMBS

- Clear and powerful shooting
- New Material : **MONOCOQUE** UD carbon
- Light weight
- New designed tip part

MATERIAL » **Double angled Full Carbon**
 CORE » **Foam core**
 BOW LENGTH » **66",68",70"**
 DRAW WEIGHT(lbs.) » **32#-50#**

** Fivics's all limbs are installed to all Fivics's riser and others.*

RECURVE BOWS

RECURVE BOWS

VELLATOR SRV

HS0125 » VELLATOR SRV RISER

- Flawless coating
- Showy color from painting
- Perfect centroidal balance

PROCESSING » CNC
 WEIGHT » 1,260g
 MATERIAL » AL 6061
 TYPE » RH/LH
 GRIP » Plastic
 COLOR » Painted

LENGTH
25



Black Blue Red Yellow



NEW

VELLATOR

LGF01 » VELLATOR FOAM LIMBS

- Foam core only
- Makes high speed arrow
- New designed tip

MATERIAL » UD CARBON
 CORE » M-FOAM CORE
 BOW LENGTH » 66", 68", 70"
 DRAW WEIGHT [lbs.] » 22#-38#

* Fivics's all limbs are installed to all Fivics's riser and others.

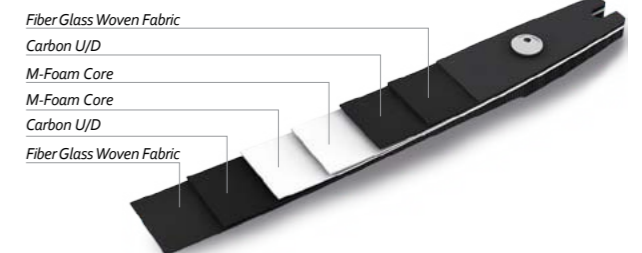

RECURVE BOWS

RECURVE BOWS

VELLATOR

HV0225 » VELLATOR 25" RISER
HV0223 » VELLATOR 23" RISER

- The lightest weight
- Only 1,100grams
- Flawless coating
- Showy color from painting
- Perfect centroidal balance

PROCESSING » Forged & CNC
 WEIGHT » 1,100g(25")/1,070(23")
 MATERIAL » AL 6061
 TYPE » RH
 GRIP » Plastic
 COLOR » Anodized
 LENGTHS » 23",25"



Black Silver Brown Blue Red Pink Gold



VELLATOR

LVW02 » VELLATOR WOOD LIMBS

- Wood core only
- Makes high speed arrow
- New designed tip
- Crosse carbon applied

MATERIAL » UD CARBON
 CORE » Wood
 BOW LENGTH » 66",68",70"
 DRAW WEIGHT(lbs.) » 22#-38#

* Fivics's all limbs are installed to all Fivics's riser and others.

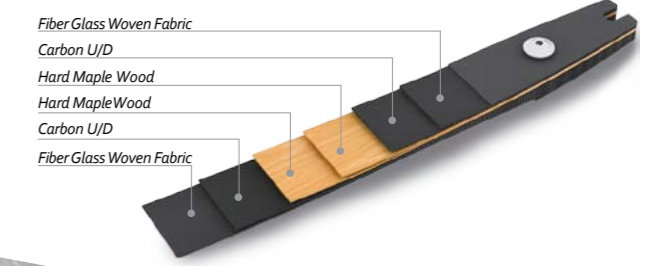

RECURVE BOWS

RECURVE BOWS



New recurve sight, FV-300

8pcs of rails inside of head parts hold all surface of sight and make strong stability. Accuracy adjustment function make better movement compared to Wormgear and extra dampers and weights reduce the vibration.

FULL POWER AHEAD

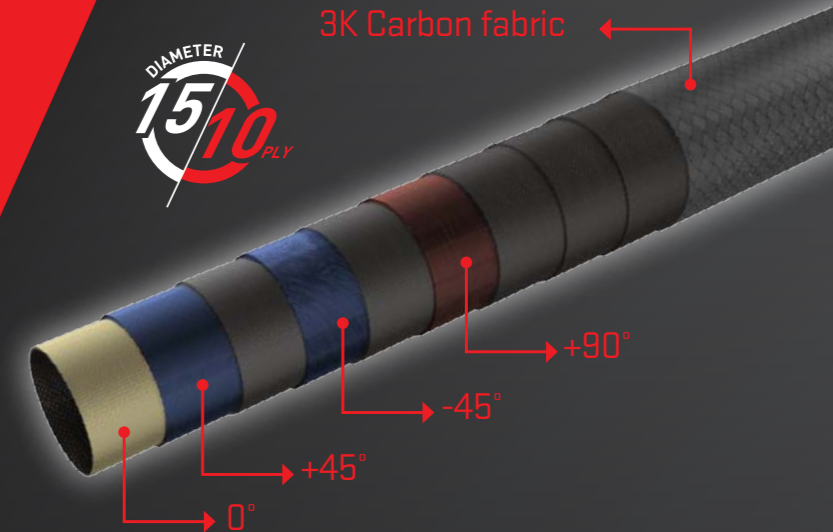
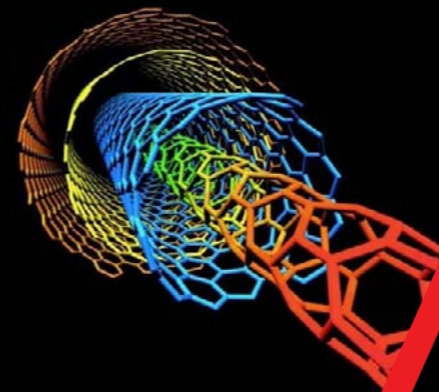

FIVICS STABILIZERS



New products, Phoenix1500D has unique extender system which is not existed and improved more on specially, joint failure part between riser and extender parts from other brands. High density carbon is included in aluminum construction and it prevents joint failure issue and reduces vibration.

Phoenix1500D has 15diameter with 10PLY carbon pipe and strong accuracy against wind. Even it has thin diameter, but due to laminated structure, it makes possible to reduce low vibration with short wave.

Fivics has developed a carbon nano-tube to apply with nano carbon stabilizer. CNT(carbon nanotube) is still invested by Fivics and we have made Non conjugated Polymer, carbon tube - epoxy complex and this technology makes 30% more stronger strength inside of carbon.

BEST QUALITY FIVICS ACCESSORIES



FIVICS ACCESSORIES



FV-300 » FV-300 SIGHT

- Designed for Olympic style / recurve bows
- Special designed weight and damper are excluded, but you can attach
- VTS (Variable Tension System)
- elevation travel tension adjustment

SIZE » **Extention 9"**
 TYPE » **RH /LH**
 MATERIAL » **Aluminum, Carbon**

NEW



FV-150S » FV-150S SIGHT

- Designed for Olympic style / recurve bows
- Special designed weight and damper are excluded, but you can attach

SIZE » **Extention 8"**
 TYPE » **RH /LH**
 MATERIAL » **Aluminum, Carbon**

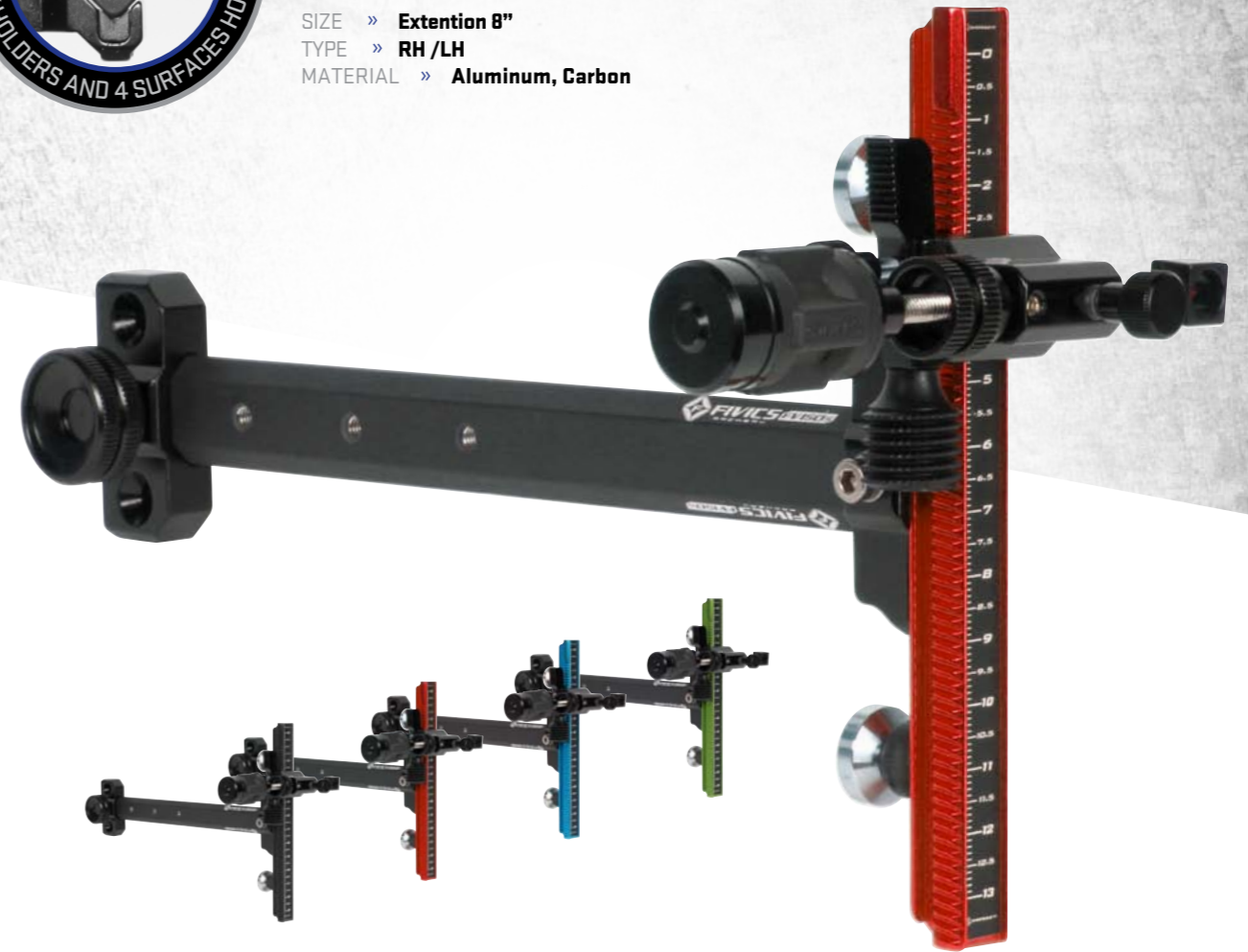

ACCESSORIES

ACCESSORIES

SGP01 » SIGHT PIN (SQUARE)

- Designed for Olympic style / recurve bows
- Apply all of sights

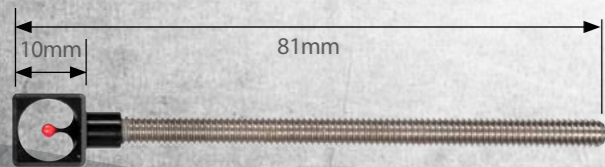

Black

SGP02 » SIGHT PIN (ROUND)

- Designed for Olympic style / recurve bows
- Apply all of sights

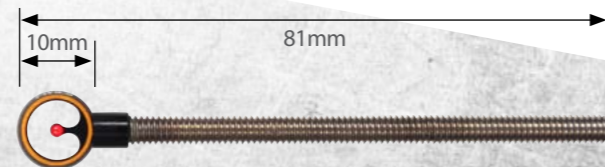

Black Gold

SIGHT DAMPERS

Extra special designed weight and damper are included



FVW501

FVW502

PHOENIX LINAFFECT WIND / 5000™

- STP15CL » PHEONIX 15000-B STABLIZER LONG(COMPOUND)
- STP15RL » PHEONIX 15000-A STABLIZER LONG(RECURVE)
- STP15S » PHEONIX 15000-A STABLIZER SIDE (COMPOUND, RECURVE)
- STP15RX » PHEONIX 15000-A STABLIZER EXTENDER (RECURVE)

DIAMETER » 15.5mm
LENGTH » Long : 26", 28, 30" / Side : 8", 10", 11", 12", 13", 15" / Extender : 4", 5"
Type » A(Recurve type), B(Compound type)

* Suitable weight(All weight can be used for other stabilizers, but we recommend you to us the above in advance)

A TYPE RECURVE

■ Carbon Shaft + Aluminum frame structure make strong attachment of cap part.



B TYPE COMPOUND

■ Inner weight Extender is included(long)



■ Double structures of damper only move toward shooting way and there is no slop and slag. Efficient reducing vibration!



■ 3 kid of weights are available and easy to assemble what you need along with headless bolts. **Weight** : 26g/52g/104g

CD1500 » PX1500 DAMPER



PX1500 WEIGHT



NEW



PHOENIX 15000-A STABLIZER LONG(RECURVE)

PHOENIX 15000-B STABLIZER LONG(COMPOUND)

PHOENIX

- STP01L » PHOENIX LONG STABILIZER
- STP01S » PHOENIX SIDE STABILIZER
- STP01E » PHOENIX EXTENDER

- Both recurve & compound
- High elastic cross carbon
- Removing weight all at once
- Attaching the weight as much as you need by using of special designed aluminum cap
- Absorbing noise system
- Stabilizer screw top
- Internal thickened extender

DIAMETER » 22mm
LENGTH » Long : 24", 27", 30", 33" / Side : 10", 11", 12", 15", 17"
Extender : 4", 5", 6"
WEIGHT » 152g(30"), 90g(12")

* Suitable weight(All weight can be used for other stabilizers, but we recommend you to us the above in advance)

VBM01 » MAN V-BAR

Upgraded connecting bolt
ANGLE » 40° / 45° **MATERIAL** » Aluminum
COLOR » BLACK



DV1500 » DC1500 DAMPER



DW1500 » DW1500 WEIGHT



ACCESSORIES

ACCESSORIES

CEX1900 STABILIZER SYSTEM

- STC19L » CEX1900 LONG STABILIZER**
- STC19S » CEX1900 SIDE STABILIZER**
- STC19E » CEX1900 EXTENDER**

- 7 colors available
- Special metallic coating with vivid color
- Chrome coated cap
- Thickened extender
- Absorbing noise system
- Stabilizer screw top
- FSP system : Four Strong Pillar system
- One color extender

DIAMETER » 19mm
 EXTENDER DIAMETER » 21mm
 LENGTH » Long : 26", 28", 30" / Side : 10", 11", 12"
 / Extender : 4", 5", 6"
 WEIGHT » 130g(30"), 86g(12")

** Suitable weight(All weight can be used for other stabilizers, but we recommend you to us the above in advance)*

VBM01 » MAN V-BAR

Upgraded connecting bolt
 ANGLE » 40° / 45° MATERIAL » Aluminum
 COLOR » BLACK



VD200 » VD200 DAMPER



VWT 200 » VWT 200 WEIGHT



VELLATOR

- STV01L » VELLATOR LONG STABILIZER**
- STV01S » VELLATOR SIDE STABILIZER**
- STV01E » VELLATOR EXTENDER**

- Including special laminating materials
- Damper and weight head included
- Absorbing noise system
- stabilizer + damper + weight head

DIAMETER » 18mm
 LENGTH » Long : 26", 28", 30" / Side : 9", 10", 12" / Extender : 3", 4", 5"
 WEIGHT » 130g(30"), 78g(12")

** Suitable weight(All weight can be used for other stabilizers, but we recommend you to us the above in advance)*

VBM01 » MAN V-BAR

Upgraded connecting bolt
 ANGLE » 40° / 45° MATERIAL » Aluminum
 COLOR » BLACK



XEDA01 » XENIA DAMPER



XEWH01 » XENIA WEIGHT



ACCESSORIES

ACCESSORIES

VBM01 » MAN V-BAR

Upgraded connecting bolt
 ANGLE » 40° / 45° MATERIAL » Aluminum
 COLOR » BLACK



VBT01 » COM V-BAR

Easy to adjust, but strong holding for compound bow
 MATERIAL » Aluminum



VBT04 » TR V-BAR

Easy to adjust, but strong holding for recurve bow
 MATERIAL » Aluminum



VBCC02 » COM CONNECTING BOLT

Quick disconnection
 MATERIAL » Aluminum
 ANGLE » -10°



VBE03 » ED V-bar

Quick disconnection
 ANGLE » 40° / 45° MATERIAL » Aluminum
 COLOR » BLACK



**DC1500 »
DC1500 DAMPER**



NEW

**VD200 »
VD200 DAMPER**



**VD220 »
VD220 DAMPER**



NEW

**CD1500 »
PX1500 DAMPER**



**DVZ1000 »
V-ZERO DAMPER**



**DVZ001M »
V-ZERO MINI-DAMPER**

1S45S16S 1S45S16L

*Applicable for all dampers

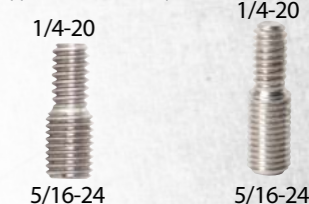

1/4-20
5/16-24

1/4-20
5/16-24



WTAL1H
 Diameter : 23mm
 Weight : 44.3g



WTAL1F
 Diameter : 23mm
 Weight : 25g



WTAL2H
 Diameter : 20mm
 Weight : 31.5g



WTAL2F
 Diameter : 20mm
 Weight : 18.2g

AL-COLOR WEIGHT

Diameter : 23mm, 20mm
 Material : Aluminum+Stainless

COLOR



**VWT 200 »
VWT 200 WEIGHT**

Diameter : 24mm
 Weight : Head-38g / Flat-38g



PX1500 WEIGHT

Diameter : 29mm
 Weight : 26g/52g/104g



WT15002

WT15001

**DW1500 »
DW1500 WEIGHT**

Diameter : 26mm
 Weight : Head-49g / Flat-50g



NEW

ACCESSORIES

ACCESSORIES



TNS100AL »
TNS100AL UPSTABILIZER
 Weight : 90g



NEW

UD1500 »
PX1500 UPSTABILIZER



TNV 2300 »
TNV 2300 UPSTABILIZER
 Weight : 80g



SM740 » SM740 CUSHION PLUNGER

Window checking



Thread : 5/16" - 24
 Adjustable Length : min 19.5mm, max 26.5mm



SM540 » SM540 CUSHION PLUNGER

Compact size to make easy setting



Thread : 5/16" - 24
 Adjustable Length : min 19.5mm, max 26.5mm

BRS001 » BUTTERFLY REST

Ambidextrous Design



MRS001 » MR REST

Stainless steel ensured durability while reducing friction.



TCS001 » TC REST

Height adjustable high-end stainless steel rest.



ACCESSORIES

ACCESSORIES

SAKER



SFT04A » Saker+ Plus finger tab

SIZE » L / M / S (RH / LH)

Saker+ Plus finger tab has 4mm of thickness and added 3 weight control and 5 angle adjustment system by using of precisely machining aluminum plate.

Saker+ Plus finger tab can be adjusted depending on individual characteristics and allows more stable hooking position and it makes possible to shoot perfectly in any competition.

And also, it is very easy to cover the special parts for the thumb and little finger.

We have considered only shooter's convenience and individual characteristics always.

Saker+ Plus finger tab's spacer is designed for the bending of the shaping as well it looks like the elephant-shape and makes comfortable for shooters.

Fivics is using high quality cordovan leathers only which is provided by H company with one hundred years history in U.S.A

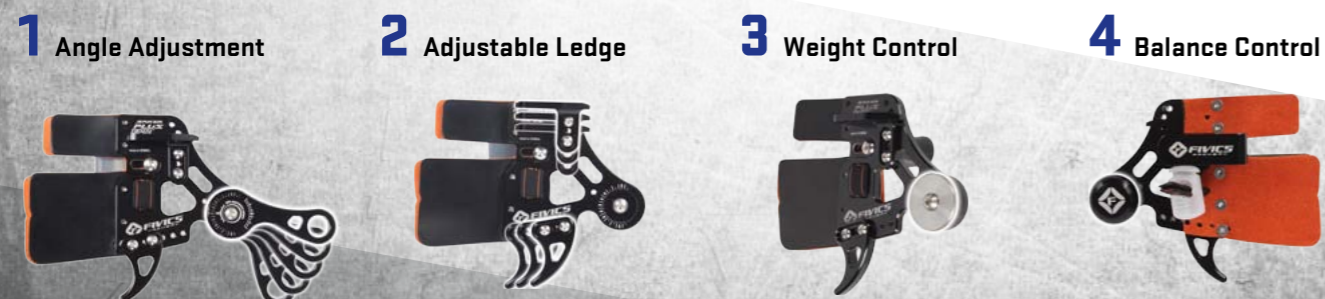

- Ergonomic design
- Adjustable ledge
- Replaceable face and backing
- Optional finger spacer available

SFT01A » SAKER 1
 SIZE » XL / L / M / S / XS / XXS (RH / LH)
 LEATHER » Cordovan



COLOR
 XL L M S XS XXS
 Dark Blue Blue Red Yellow Purple Dark Green

BFT01A » BRASS SAKER 1
 SIZE » L / M / S (RH / LH)
 WEIGHT » L 162g, M 152g, S 144g
 LEATHER » Cordovan



BFT02A » BRASS SAKER 2
 SIZE » L / M / S (RH / LH)
 WEIGHT » L 150g, M 140g, S 136g
 LEATHER » Cordovan



SFT02A » SAKER 2
 SIZE » XL / L / M / S / XS / XXS (RH / LH)
 LEATHER » Cordovan



COLOR
 XL L M S XS XXS
 Dark Blue Blue Red Yellow Purple Dark Green

SFT03A » SAKER 3
 SIZE » L / M / S (RH / LH)
 LEATHER » Cordovan



COLOR
 L M S
 Blue Red Yellow

EP001 » SAKER 1 FINGER TAB FRAME EP

EP001 only fit Saker 1 finger tab
 It offers top shooters another value for their hooking direction, comfortable and balanced.
 This component enhances the saker finger tab's Ergonomic design



Size » saker1 XL , L = EP (L size)
 saker1 M , S = EP (M size)
 saker1 XS , XXS = EP (S size)

WA RULES Book3, Chapter 11, Article 11.18
 The Technical Committee concluded that if the bar extends to the wrist but not beyond (extends at or before the contact point between the hand and the wrist), then the extension is legal.
 World Archery C&R Committee, 22 September 2014

ACCESSORIES

ACCESSORIES

FINGER TAB

POLITE 3 CARE

PFT03 » POLITE 3 FINGER TAB

- Emphasizes the sense of unity in your hands.
- Absolute stability, accuracy, and sense of unity of hooking
- 5 Distribution and support of the optimal force by using the whole fingers
- Ergonomic 3D design
- Aluminium & anodizing surface treatment

SIZE » L / M / S (RH / LH)
 COLOR » Champagne Gold



POLITE 2 CARE

PFT02 » POLITE 2 FINGER TAB

- **Adjustable ring finger rest**
- Emphasizes the sense of unity in your hands.
- Absolute stability, accuracy, and sense of unity of hooking
- 5 Distribution and support of the optimal force by using the whole fingers
- Ergonomic 3D design
- Aluminium & anodizing surface treatment

SIZE » L / M / S (RH / LH)
 COLOR » Champagne Gold

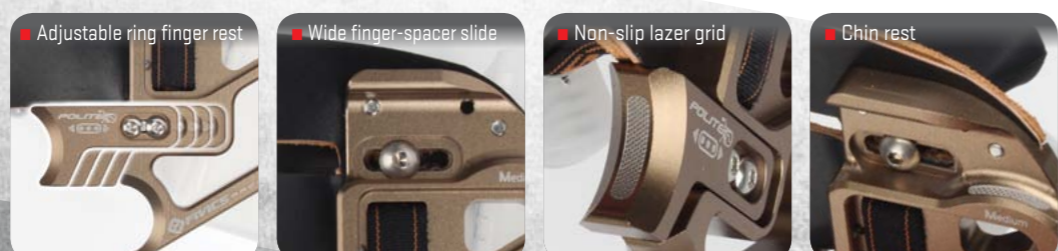

H4YPER

HPT01 » HYPER FINGER TAB

PLATE MATERIAL » Aluminum
 LEATHER » Cordovan
 SIZE » S, M, L



FINGER SPACER

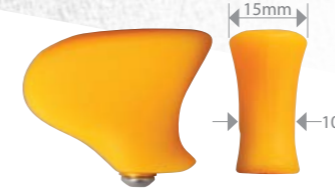

FS004D
 Material : Rubber
 Size : 39.8 x 29.3 x 16.2mm
 Weight : 14g
 COLOR
 Red Yellow Green Blue Purple Black



FS006
 Material : Plastic
 Size : 40 x 29 x 10mm
 Weight : 10g
NEW



ACCESSORIES

ACCESSORIES



CARBON

AC05CT » CARBON T-GAUGE BOW SQUARE

Material : Carbon

ST001S » AUTOMATIC (SHORT)
ST001L » AUTOMATIC (LONG)
 BOW STAND

Height : 44cm [ST001S], 65cm [ST001L]
 Weight : 573g [ST001S], 680g [ST001L]
 Material : Aluminum



STG00 » 1GABO
 BOW STAND

Height : 44cm
 Material : Aluminum

COLOR



AC23PU »
FIVICS ARROW PULL



Black Green Blue Red

FIVICS
GEAR

Luxury

Secret masterpieces
 World famous craftsman designed and made
 Research, production, planning and design.

BCHD02 » AEGIS HARD CASE SINGLE NEW

- Lightweight
- Strong enough against bad moving
- Special designed wheels
- Showy colors
- This model can hold up to one recurve bows and their accessories

Size : **830×320×190mm**
 Material : **ABS+PC**
 Pocket : **1pcs**

**Recommended maximum weight : 23kg*



Black

Silver

White

BCHD01 » AEGIS HARD CASE DOUBLE UP GRADE

- High quality hardcase
- This model can hold up to two recurve bows and their accessories

Size : **33" X 15" X 10"**
 Material : **ABS+PC**
 Pocket : **1pcs**

**Recommended maximum weight : 23kg*



Pink

Blue

Red

Black

Silver

White

**ECRC01
HARDCASE RAIN COVER**



**ECB01
HARDCASE BELT**



Rain cover / Case belt included



**ECRC01
HARDCASE RAIN COVER**



**ECB01
HARDCASE BELT**



Rain cover / Case belt included



GEAR

GEAR

ATTACK

BACKPACK

ATTB001 » ATTACK BACKPACK

- 57L wide pocket
- 3way transformation
- Tactical design
- Modular lightweight Load-carrying equipment
- Multi carrier
- Safe inner protection
- Not only archery, but also your daily life

ATTACK

POUCH

ATTB002 » ATTACK SCOPE POUCH

- MOLLE SYSTEM POUCH
- Size » 500x150



ATTB005 » ATTACK STABILIZER POUCH

- MOLLE SYSTEM POUCH
- Size » 880x75mm



ATTB003

- Size » 220x45x180



ATTB004

- Size » 150x45x155



GEAR

GEAR



ATTACK

EASY COMPOUND BOW CASE

ATE001 »
EASY COMPOUND BOW CASE



BC802TM » TENTRON-M BACKPACK

Size : 11.8" X 7.8" X 26.7"
Pocket : 1pcs



- + Arrow tube
- + Equipment case
- + Riser & Limbs case included
- + Rain Cover

BC2L01 » Folding case(2 level)

- Compact size
- Including riser & limbs and arrow and equipment cases



ATTACK

EASY RECURVE BOW CASE

ATE002 »
EASY RECURVE BOW CASE



GEAR

GEAR



**ATB001 »
COACH BAG**

The bag which coaches or shooters can bring at competition field along with I pad, mobile, score book, note book and etc...

EC04 » FIVICS ARROW TUBE



RLC01 » RISER & LIMBS CASE



EC03 » TOOL BOX



FICAM » FIVICS CAM PROTECTOR



**QV01UNTB » UNICO QUIVER LARGE
QV01UNTS » UNICO QUIVER SMALL**

Artificial leather provide you with elegance.

Extra "L" size belts are on sales

SIZE » Large / Small
WEIGHT » L-502g / S-418g
TYPE » RH / LH



QV01UNB » UNICO BACK

Artificial leather provide you with elegance.

Extra "L" size belts are on sales

TYPE » RH / LH RH / LH



GEAR

GEAR



QV02AT » ACCENDO TOURNAMENT

Light weight (630g)
Large pocket for accessories

TYPE » RH / LH

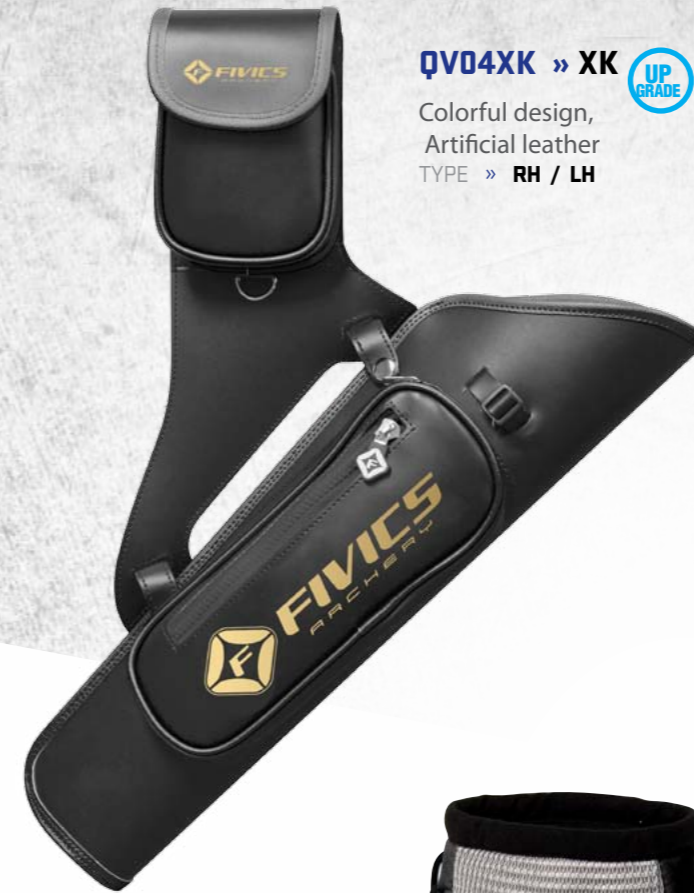

QV04XK » XK

UP
GRADE

Colorful design,
Artificial leather
TYPE » RH / LH

HPTKN » NATIONAL HAND POCKET



AVAILABLE FOR
ANY COUNTRIES

HPTKS » HAND POCKET



QV02AB » ACCENDO BACK

Light weight (260g)
Large pocket for accessories

TYPE » RH / LH



GEAR

GEAR

CG02BD » BAND

Band system
Moving free

SIZE » L, M, S
TYPE » RH / LH



CG001A2 » A2

Adjust a shoulder band
The button system to adjust sides

SIZE » L, M, S
TYPE » RH / LH
COLOR



CLOTHES

Size : XS / S / M / L / XL / XXL

AC29JW



AC29JY



CAPS



AC17CA



NAVY White AC14CA

AC17SO »

FIVICS LOGO SOCKS(3PAIRS=1SET)



AM001 » ORGANIC WEB



AMH01 » SILICON JELLY

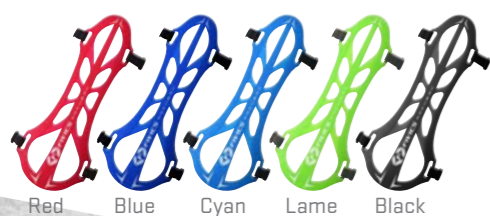

Red Blue Cyan Lime Black



White Blue Green Yellow Red Pink Purple

AC26CS »

COOL ARM SLEEVE



AC25UMBL » UMBRELLA

length : 1m
opened size : 1m 60cm



AC04CL »
CLOCK



AC20LP » Limb Protector

The device to protect the tip part and your feet
when setting up bows.

Size : 56X97 mm
Material : Rubber



FIVICS ARROWS



ASIA ONLY ONE WA TARGET FACE
LICENSED MANUFACTURER



Official World Archery Target Face
World Archery Target License #9

FIVICS PERFECT TARGET FACE

Design your shooting !!

Challenge beyond limited record



FIVICS Target Face Funtion

[Out Door, In Door, Training, Field]



- + Material : Polyester
- + Thickness : 0.29mm
- + Tensile strenght (kg/cm2) : (L- 40,0 / W- 17,0)
- + Temperature range : -32 ~ 260 C
- + Printing error range : 99,9% (Best "Quality")

[Available also in economic Target face in all the range of size]

XQ-3.15™

ARNX001 » XQ-3.15 ARROW (Recurve & Compound)

Excellent in grouping of arrows with stability and accuracy

XQ-3.15, it took more than 3 years testing and developing by Korean national team member, Mr. Jang Young Ho and during testing, we Fivics found the perfect inner diameter to make stability and accuracy between point and shaft, ϕ 3.15

Uniform production makes equal specification and has outstanding arrow grouping and reducing arrow damage rate which is always troublesome of carbon arrow's natural.

Fivics also found new material for XQ-3.15 arrow and it is MC 46ton carbon which has strong points in accuracy and durability of epoxy resin.

We, Fivics, hereby can tell you that XQ-3.15 is perfect for Archery competition arrow due to these outstanding reasons.

- Advanced Technology, Extreme Accuracy.
- Straightness: \pm 0.001".
- Weight tolerance: \pm 1.0 grains.
- Spine selection tolerance: \pm 0.002".



Stainless Steel Target Point

- Q1/120 (400-450)
- Q2/120 (500-650)
- Q3/120(700-1000)



Pin Nock Adapter

- Q1 (400-450)
- Q2(500-650)
- Q3(700-1000)



FIVICS Pin Nock (PI-N)



Size	Legnth	Weight(Grain)	Diameter	Spine	Qty	Recommended Point Weight ange
400	32	268.6	5.22	400	12pack	Q1/120g
450	32	243.6	5.09	450	12pack	
500	32	225.4	4.95	500	12pack	
550	32	214	4.9	550	12pack	Q2/120g
600	32	202.6	4.8	600	12pack	
650	32	192.4	4.73	650	12pack	
700	32	181.6	4.62	700	12pack	Q3/120g
750	32	177.4	4.6	750	12pack	
800	32	167.6	4.59	800	12pack	
850	32	161.3	4.52	850	12pack	Q3/120g
900	32	156.7	4.48	900	12pack	
1000	32	147.5	4.41	1000	12pack	

TEN Pro

ARTR001 » TENPRO

Strong durability against wind due to 30ton of carbon applied.

New Tenpro is one of ultra slim arrow designed for recurve shooters. There are lots of functions of arrows in Tenpro, but the most important thing is that it has a strong fortress in the middle part and it allows arrow goes straight way. And also, its own ultra slim shape can reduce the wind and very useful and optimized for FITA, NAA and NFAA long field shooting.

30tons of carbon makes extreme speed, strength and consistence in shooting and there speedy restoration from multi-shooting.

- Advanced Technology, Extreme Accuracy.
- Straightness: \pm 0.002".
- Weight tolerance: \pm 1.0 grains.
- Spine selection tolerance: \pm 0.002".



Stainless Steel Target Point

- T1/120 (300)
- T2/120 (400-450)
- T3/120 (500-550)
- T4/120 (600-800)
- T5/120 (900-1200)



Pin Nock Adapter

- T1 (300)
- T2 (400-450)
- T3 (500-550)
- T4 (600-800)
- T5 (900-1200)



FIVICS Pin Nock (PI-N)



Size	Legnth	Weight(Grain)	Diameter	Spine	Qty	Recommended Point Weight ange
300	32	397.6	6.3	300	12/pack	T1/120g
400	32	335.6	5.98	400	12pack	T2/120g
450	32	302.6	5.79	450	12pack	
500	32	279	5.63	500	12pack	
550	32	260.5	5.55	550	12pack	T3/120g
600	32	250.1	5.45	600	12pack	
650	32	236.4	5.4	650	12pack	
700	32	231.7	5.38	700	12pack	T4/120g
800	32	211.4	5.22	800	12pack	
900	32	194.5	5.1	900	12pack	
1000	32	189.2	5.09	1000	12pack	T5/120g
1100	32	171.5	4.96	1100	12pack	
1200	32	162.2	4.9	1200	12pack	

ARROW & TARGET

ARROW & TARGET

MACH1

MN1S001 » MACH1 ARROW

Strong durability against wind due to 24ton of carbon applied.

New Mach1 is one of ultra slim arrow designed for recurve shooters. There are lots of functions of arrows in Mach1, but the most important thing is that it has a strong fortress in the middle part and it allows arrow goes straight way.

24tons of carbon makes extreme speed, strength and consistence in shooting and there speedy restoration from multi-shooting.

- Advanced Technology, Extreme Accuracy.
- Straightness: $\pm 0.002''$.
- Weight tolerance: ± 1.0 grains.
- Spine selection tolerance: $\pm 0.0025''$.



Stainless Steel Target Point

- M1/120 (500-700)
- M2/120 (800-1000)
- M3/120 (1100-1500)



Pin Nock Adapter

- M1(500-700)
- M2(800-1000)
- M3(1100-1500)



FIVICS Pin Nock (PI-N)



Size	Legnth	Weight(Grain)	Diameter	Spine	Qty	Recommended Point Weight ange
500	31	252.5	5.89	500	12 pack	M1/110-120g
600	31	216	5.68	600	12 pack	M1/110-120g
700	31	201.4	5.58	700	12 pack	M1/110-120g
800	31	186.5	5.48	800	12 pack	M2/110-120g
900	31	179	5.43	900	12 pack	M2/110-120g
1000	31	159.8	5.32	1000	12 pack	M3/110-120g
1100	31	154.3	5.22	1100	12 pack	M3/110-120g
1200	31	141	5.2	1200	12 pack	M3/110-120g
1300	31	129	5.18	1300	12 pack	M3/110-120g
1400	31	127	5.11	1400	12 pack	M3/110-120g
1500	31	124	5.05	1500	12 pack	M3/110-120g

ZEILO

ARZI001 » ZEILO (Intermediate)

ZEILO is the target arrow for youths.

NEW cross weave of pure carbon layer gives it's unequaled strength, even on lightweight pure carbon arrows. This cross-woven method of construction is proven to deliver exceptional strength without adding weight.

- Advanced Technology, Extreme Accuracy.
- Straightness: $\pm 0.002''$.
- Weight tolerance: ± 1.0 grains.
- Spine selection tolerance: $\pm 0.0025''$.



Stainless Steel Target Point

- 120 (500-1500)
- 110 (500-1500)



Pin Nock Adapter SI-1000



FIVICS Pin Nock (PI-N)



Shaft Size	Qty	ShWeight (Grain)	Spine	Recommended Point Weight Range
500	12 pack	9.22	500	110g / 120g
600	12 pack	8.76	600	110g / 120g
700	12 pack	8.18	700	110g / 120g
800	12 pack	7.61	800	110g / 120g
900	12 pack	7.26	900	110g / 120g
1000	12 pack	6.97	1000	110g / 120g
1100	12 pack	6.72	1100	110g / 120g
1200	12 pack	5.59	1200	110g / 120g
1300	12 pack	6.54	1300	110g / 120g
1400	12 pack	6.26	1400	110g / 120g
1500	12 pack	6.07	1500	110g / 120g

ARROW & TARGET

ARROW & TARGET

MACH3

ARMC001 » MACH3 ARROW

Beginner **Carbon** Arrow

Size : 400/500/600/700/800/900/1000/1100/1300/1500

/1800(11 kinds of spines)

Shaft only : one dozen/12pcs

Finished arrow : one dozen/12pcs = shaft + 1.65" vanes +

In-nock + break-off point

Straightness: ± 0.004"

MACH TARGET POINTS

90-100g



Vanes

1.65"



In Nock



Shaft Size	Qty	Stock Lengh inch	Spine	Point Weight
400	12 pack	33"	500	90-100g
500	12 pack	33"	500	90-100g
600	12 pack	33"	600	90-100g
700	12 pack	33"	700	90-100g
800	12 pack	33"	800	90-100g
900	12 pack	33"	900	90-100g
1000	12 pack	30"	1000	90-100g
1100	12 pack	30"	1100	90-100g
1300	12 pack	30"	1300	90-100g
1500	12 pack	30"	1500	90-100g
1800	12 pack	30"	1800	90-100g

NINJA

ARNN001 » NINJA ARROW

Beginner **Carbon Composite** Arrow

Size : 400/500/600/700/800/900/1000/1100/1300/1500/

1800(11 kinds of spines)

Shaft only : one dozen/12pcs

Finished arrow : one dozen/12pcs = shaft + 1.65" vanes +

In-nock + break-off point

Straightness: ± 0.006"

NINJATARGET POINTS

70-80g



Vanes

1.65"



In Nock



Shaft Size	Qty	Stock Lengh inch	Spine	Point Weight
400	12 pack	33"	500	70-80g
500	12 pack	33"	500	70-80g
600	12 pack	33"	600	70-80g
700	12 pack	33"	700	70-80g
800	12 pack	33"	800	70-80g
900	12 pack	33"	900	70-80g
1000	12 pack	30"	1000	70-80g
1100	12 pack	30"	1100	70-80g
1300	12 pack	30"	1300	70-80g
1500	12 pack	30"	1500	70-80g
1800	12 pack	30"	1800	70-80g

ARROW & TARGET

ARROW & TARGET

XQ-3.15

Bow Draw Weight	23"	24"	25"	26"	27"	28"	29"	30"	31"	32"	33"
13-15 lbs.								XQ1000	XQ1000	XQ900	XQ900
16-18 lbs.							XQ1000	XQ1000	XQ900	XQ900	XQ850
19-21 lbs.						XQ1000	XQ1000	XQ900	XQ900	XQ850	XQ800
22-24 lbs.					XQ1000	XQ1000	XQ900	XQ900	XQ850	XQ800	XQ750
25-27 lbs.				XQ1000	XQ1000	XQ900	XQ900	XQ850	XQ800	XQ750	XQ700
28-30 lbs.			XQ1000	XQ1000	XQ900	XQ900	XQ850	XQ800	XQ750	XQ700	XQ650
31-33 lbs.		XQ1000	XQ1000	XQ900	XQ900	XQ850	XQ800	XQ750	XQ700	XQ650	XQ600
34-36 lbs.	XQ1000	XQ1000	XQ900	XQ900	XQ850	XQ800	XQ750	XQ700	XQ650	XQ600	XQ550
37-39 lbs.	XQ1000	XQ900	XQ900	XQ850	XQ800	XQ750	XQ700	XQ650	XQ600	XQ550	XQ500
40-42 lbs.	XQ900	XQ900	XQ850	XQ800	XQ750	XQ700	XQ650	XQ600	XQ550	XQ500	XQ450
43-45 lbs.	XQ900	XQ850	XQ800	XQ750	XQ700	XQ650	XQ600	XQ550	XQ500	XQ450	XQ400
46-48 lbs.	XQ850	XQ800	XQ750	XQ700	XQ650	XQ600	XQ550	XQ500	XQ450	XQ400	
49-51 lbs.	XQ800	XQ750	XQ700	XQ650	XQ600	XQ550	XQ500	XQ450	XQ400		
52-54 lbs.	XQ750	XQ700	XQ650	XQ600	XQ550	XQ500	XQ450	XQ400			
54-56 lbs.	XQ700	XQ650	XQ600	XQ550	XQ500	XQ450	XQ400				
57-59 lbs.	XQ650	XQ600	XQ550	XQ500	XQ450	XQ400					

TENPRO | MACH1 | ZEILO

TP= TENPRO MA=MACH1 ZL= ZEILO

Bow Draw Weight	23"	24"	25"	26"	27"	28"	29"	30"	31"	32"	33"
20-lbs.	MA1500 ZL1500	MA1500 ZL1500	MA1500 ZL1500	MA1400 ZL1400	MA1300 ZL1300	MA1200 ZL1200	TP1200 MA1200 ZL1100	TP1100 MA1100 ZL1000	TP1000 MA1000 ZL900	TP900 MA900 ZL900	TP800 MA800 ZL800
22-lbs.	MA1500 ZL1500	MA1500 ZL1500	MA1400 ZL1400	MA1300 ZL1300	MA1200 ZL1200	TP1200 MA1200 ZL1100	TP1100 MA1100 ZL1000	TP1000 MA1000 ZL900	TP900 MA900 ZL900	TP800 MA800 ZL800	TP800 MA800 ZL800
24-lbs.	MA1500 ZL1500	MA1400 ZL1400	MA1300 ZL1300	MA1200 ZL1200	TP1200 MA1200 ZL1100	TP1100 MA1100 ZL1000	TP1000 MA1000 ZL900	TP900 MA900 ZL900	TP800 MA900 ZL800	TP800 MA800 ZL800	TP700 MA700 ZL700
26-lbs.	MA1400 ZL1400	MA1300 ZL1300	MA1200 ZL1200	MA1200 ZL1100	MA1100 ZL1000	MA1000 ZL900	MA900 ZL900	MA800 ZL800	MA800 ZL800	MA700 ZL700	MA700 ZL700
28-lbs.	MA1300 ZL1300	MA1200 ZL1200	TP1200 MA1200 ZL1100	TP1100 MA1100 ZL1000	TP1000 MA1000 ZL900	TP900 MA900 ZL900	TP800 MA800 ZL800	TP800 MA800 ZL800	TP700 MA700 ZL700	TP700 MA700 ZL700	TP650 MA600 ZL600
30-lbs.	MA1200 ZL1200	TP1200 MA1200 ZL1100	TP1100 MA1100 ZL1000	TP1000 MA1000 ZL900	TP900 MA900 ZL900	TP800 MA800 ZL800	TP800 MA800 ZL800	TP700 MA700 ZL700	TP700 MA700 ZL700	TP650 MA600 ZL600	TP600 MA600 ZL600
32-lbs.	TP1200 MA1200 ZL1100	TP1100 MA1100 ZL1000	TP1000 MA1000 ZL900	TP900 MA900 ZL900	TP800 MA800 ZL800	TP800 MA800 ZL800	TP700 MA700 ZL700	TP700 MA700 ZL700	TP650 MA600 ZL600	TP600 MA600 ZL600	TP550 MA500 ZL500
34-lbs.	TP1100 MA1100 ZL1000	TP1000 MA1000 ZL900	TP900 MA900 ZL900	TP800 MA800 ZL800	TP800 MA800 ZL800	TP700 MA700 ZL700	TP700 MA700 ZL700	TP650 MA600 ZL600	TP600 MA600 ZL600	TP550 MA500 ZL500	TP500 MA500 ZL500
36-lbs.	TP1000 MA1000 ZL900	TP900 MA900 ZL900	TP800 MA800 ZL800	TP800 MA800 ZL800	TP700 MA700 ZL700	TP700 MA700 ZL700	TP650 MA600 ZL600	TP600 MA600 ZL600	TP550 MA500 ZL500	TP500 MA500 ZL500	TP450
38-lbs.	TP900 MA900 ZL900	TP800 MA800 ZL800	TP800 MA800 ZL800	TP700 MA700 ZL700	TP700 MA700 ZL700	TP650 MA600 ZL600	TP600 MA600 ZL600	TP550 MA500 ZL500	TP500 MA500 ZL500	TP450	TP400
40-lbs.	TP800 MA800 ZL800	TP800 MA800 ZL800	TP700 MA700 ZL700	TP700 MA700 ZL700	TP650 MA600 ZL600	TP600 MA600 ZL600	TP550 MA500 ZL500	TP500 MA500 ZL500	TP450	TP400	TP400
42-lbs.	TP800 MA800 ZL800	TP700 MA700 ZL700	TP700 MA700 ZL700	TP650 MA600 ZL600	TP600 MA600 ZL600	TP550 MA500 ZL500	TP500 MA500 ZL500	TP450	TP400	TP400	TP300
44-lbs.	TP700 MA700 ZL700	TP700 MA700 ZL700	TP650 MA600 ZL600	TP600 MA600 ZL600	TP550 MA500 ZL500	TP500 MA500 ZL500	TP450	TP400	TP400	TP300	TP300
46-lbs.	TP700 MA700 ZL700	TP650 MA600 ZL600	TP600 MA600 ZL600	TP550 MA500 ZL500	TP500 MA500 ZL500	TP450	TP400	TP400	TP300	TP300	
48-lbs.	TP650 MA600 ZL600	TP600 MA600 ZL600	TP550 MA500 ZL500	TP500 MA500 ZL500	TP450	TP400	TP400	TP300	TP300		
50-lbs.	TP600 ZL600	TP550 ZL500	TP500 ZL500	TP450	TP400	TP400	TP300	TP300			
52-lbs.	TP550 ZL500	TP500 ZL500	TP450	TP400	TP400	TP300	TP300				
54-lbs.	TP500 ZL500	TP450	TP400	TP400	TP300	TP300					
56-lbs.	TP450	TP400	TP400	TP300	TP300						

NC001S FIVICS Pin Nock(S)

NC001L FIVICS Pin Nock(L)

This universal pin nock fits all standard pin nock adapters. It is made from a durable polycarbonate material that performs shot after shot.

Size: S / L

Color:



Available in two size: #1 fits 12-18 strand strings
#2 fits 20-24 strand strings

AC01F » EZ FLETCHER

- EZ Fletcher is designed for putting vanes on a shaft very easily.
- automatic shaft holding system,
- angle control system
- magnetic system
- detailed adjustment system

FEATURE
MATERIAL : Aluminum
SIZE : 124 x 124 x 220
COLOR : Black



ARROW & TARGET

ARROW & TARGET

3000 ARROW CHALLENGE

FIVICS PERFECT TARGET FACE

WATER PROOF

OUTDOOR TARGET FACE

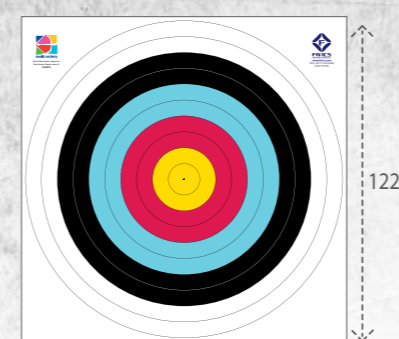

PT 001 OUTDOOR 122cm Target Face
Range: 90m / 70m / 60m
Mark dimension: 122cm X 122cm
Total dimension: 125cm X 125cm (width/length)

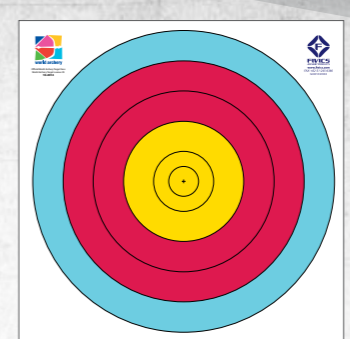

PT 005 OUTDOOR 40cm-5ring Target Face
Range: 30m / 20m
Mark dimension: 40cm X 40cm
Total dimension: 43cm X 43cm (width/length)

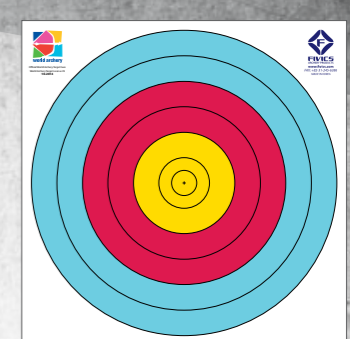

PT 007A OUTDOOR 48cm-6ring Target Face
Range: 50m
Mark dimension: 48cm X 48cm
Total dimension: 51cm X 51cm (width/length)

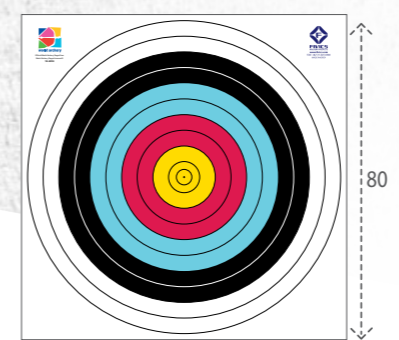

PT 002 OUTDOOR 80cm Target Face
Range: 50m / 30m
Mark dimension: 80cm X 80cm
Total dimension: 83cm X 83cm (width/length)



PT 006 OUTDOOR Triangular Target face(5Line)
Range: 30m / 20m
Mark dimension: (40cm-Center X 3Target)
Total dimension: 85cm X 85cm (width/length)

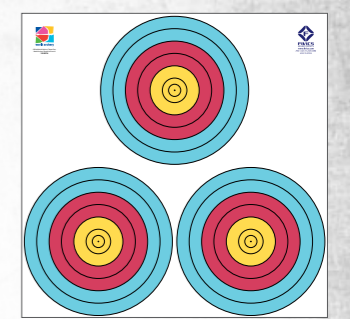

PT 007A3 OUTDOOR Triangular Target face(6Line)
Range: 50m
Mark dimension: (48cm-Center X 3Target)
Total dimension: 99cm X 98.5cm (width/length)

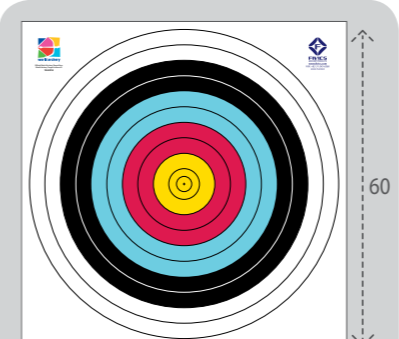

PT 003 OUTDOOR 60cm Target Face
Range: 25m
Mark dimension: 60cm X 60cm
Total dimension: 63cm X 63cm (width/length)

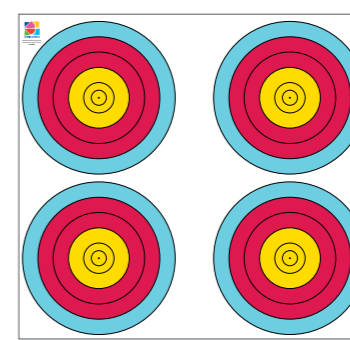

PT 007 OUTDOOR Target face(5Line)
Range: 30m / 20m
Mark dimension: (40cm-Center X 4Target)
Total dimension: 93cm X 85cm (width/length)

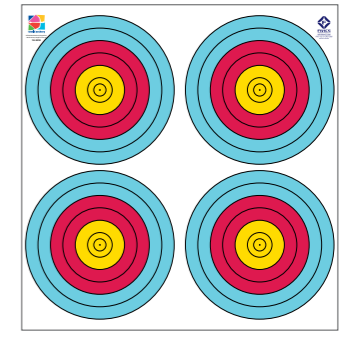

PT 007A4 OUTDOOR Triangular Target face(6Line)
Range: 50m
Mark dimension: (48cm-Center X 4Target)
Total dimension: 102cm X 105cm (width/length)

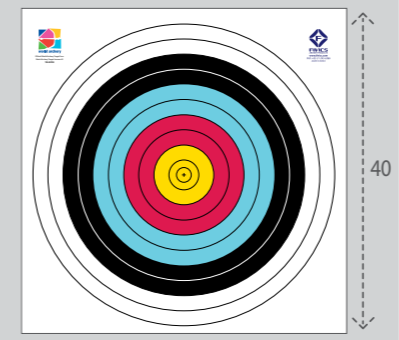

PT 004 OUTDOOR 40cm Target Face
Range: 18m
Mark dimension: 40cm X 40cm
Total dimension: 43cm X 43cm (width/length)

OUT/INDOOR TARGET FACE



Waterproof

ASIA ONLY ONE WA TARGET FACE LICENSED MANUFACTURER

ARROW & TARGET

ARROW & TARGET

INDOOR TARGET FACE

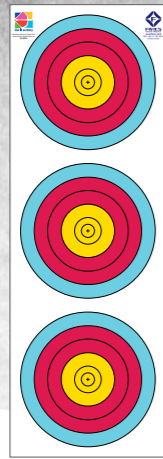

PT 008 INDOOR 20cm Target Face(18m)
Range: 18m
Mark dimension : 20cm X 3 Target
Total dimension : 23cm X 67cm (width/length)

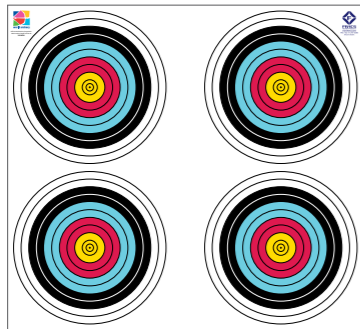

PT 009 INDOOR Single Target Face
Range: 18m
Mark dimension : 40cm X 4 Target
Total dimension : 93cm X 85cm (width/length)

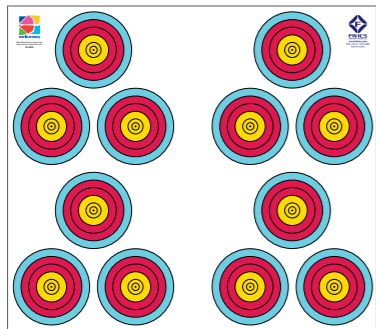

PT 011 INDOOR 20cm Triangular Triple Target Face
Range: 18m
Mark dimension : 20cm X 3 X 12 Target
Total dimension : 97cm X 85cm (width/length)

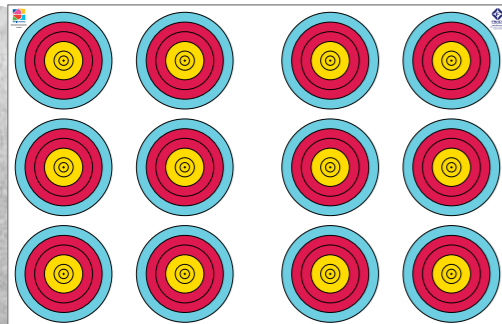

PT 010 INDOOR 12cm Target Face(18m)
Range: 18m
Mark dimension : 20cm X 12 Target
Total dimension : 103cm X 67cm (width/length)

TRAINING TARGET FACE



PT 012 TRAINING 80cm-CenterSpot Target Face(8Line)
Range : 50m/30m/20m
Mark dimension : 24cmX24cm
Total dimension : 32cmX32cm(width/length)



PT 013 TRAINING 122cm-CenterSpot Target Face(7Line)
Range : 90m/70m/60m
Mark dimension : 48.8cmX48.8cm
Total dimension : 61cmX61cm(width/length)

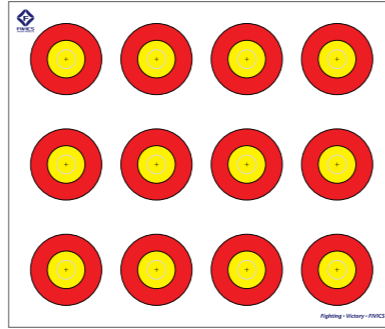

PT 020 TRAINING Target Face
Mark dimension : 52mmX52mm
Total dimension : 282mmX238mm(width/length)

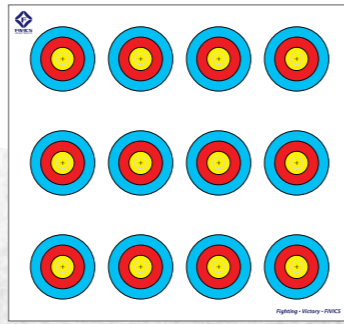

PT 021 TRAINING Target Face
Mark dimension : 48mmX48mm
Total dimension : 250mmX231mm(width/length)

FIELD TARGET FACE



PT 014 FIELD 80cm Target Face
Mark dimension : 80cmX80cm Target
Total dimension : 83cmX83cm(width/length)



PT 015 FIELD 60cm Target Face
Mark dimension : 60cmX60cm Target
Total dimension : 63cmX63cm(width/length)



PT 016 FIELD 40cm Target Face
Mark dimension : 40cmX40cm
Total dimension : 93cmX85cm(width/length)

ACADEMIC TARGET FACE



PT 017 OUTDOOR Target Face
Range: 70m
Mark dimension : 97.2cmX97.2cm
Total dimension : 103cmX103cm(width/length)

PAG001 » PERFECT SCORE SHEET

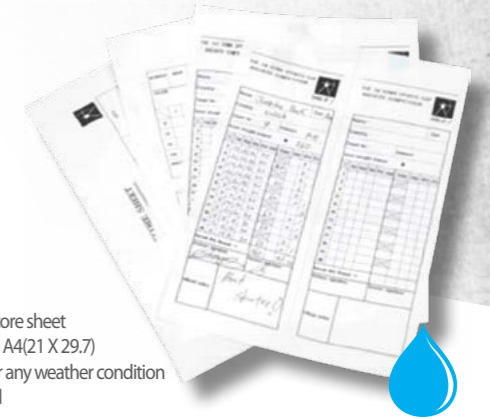

Name : Perfect score sheet
Total dimension : A4(21 X 29.7)
Applicable under any weather condition
Ink not smudged

* Blank page only
- You should print the score information or chart on the paper when you receive it.

PAG002 » TARGET SCORE BOOK



ASIA FIRST WA TARGET FACE LICENSED MANUFACTURER

ARROW & TARGET

ARROW & TARGET

RECURVE BOW



TITAN X2 RISER

LENGTHS	WEIGHT	MATERIAL	TYPE	COLOR (Anodized & Painted)
25"	1,315g	Aluminum(6061)	RH / LH	Anodized Black, Pink, Blue, Gold, Red Painted White, Yellow
27"	1,330g		RH / LH	

VELLATOR SRV RISER

LENGTHS	WEIGHT	MATERIAL	TYPE	COLOR (Painted)
25"	1,260g	Aluminum(6061)	RH / LH	Black, Blue, Red, Yellow

VELLATOR RISER

LENGTHS	WEIGHT	MATERIAL	TYPE	COLOR (Anodized)
23"	1,060g	Aluminum(6061)	RH	Black, Silver, Brown, Blue, Red, Pink, Gold
25"	1,100g			

TITAN WOOD CORE LIMBS

MATERIAL	DRAW WEIGHT (lbs.)	LENGTHS
Wood / Double angled Full Carbon	32# ~ 50#	66", 68", 70"

TITAN FOAM CORE LIMBS

MATERIAL	DRAW WEIGHT (lbs.)	LENGTHS
Foam / Double angled Full Carbon	32# ~ 50#	66", 68", 70"

VELLATOR FOAM CORE LIMBS

MATERIAL	DRAW WEIGHT (lbs.)	LENGTHS
Foam / UD Carbon	22# ~ 38#	66", 68", 70"

VELLATOR WOOD CORE LIMBS

MATERIAL	DRAW WEIGHT (lbs.)	LENGTHS
Wood / UD Carbon	22# ~ 38#	66", 68", 70"



25"

27"

25"

23"

25"

TITAN X2

VELLATOR SRV

VELLATOR



TITAN WOOD

TITAN FOAM

VELLATOR FOAM

VELLATOR WOOD